

fd dmx 1-48e

DMX LED dimmer

Digital LED dimmer with 9A constant voltage output for smooth control, especially in lower dimming range.



Properties

- Robust constant voltage dimmer with high current capacity
- Protected against short-circuit and overtemperature
- Smooth dimming control even in the lowest range
- Dimming curve matched to eye sensitivity
- Digital control with DMX control devices
- Start channel easily adjustable via rotary switch
- Plastic housing construction with cable grip

Ordering Information

Product name	fd dmx 1-48e
Item number	0000 4022

Available Versions



fd dmx 3-48e

Combinable with the following feno products



fc s.dmx 48d



fc s.dmx 144d



fc dmx 512u

fd dmx 1-48e

DMX LED dimmer

Wiring Diagram

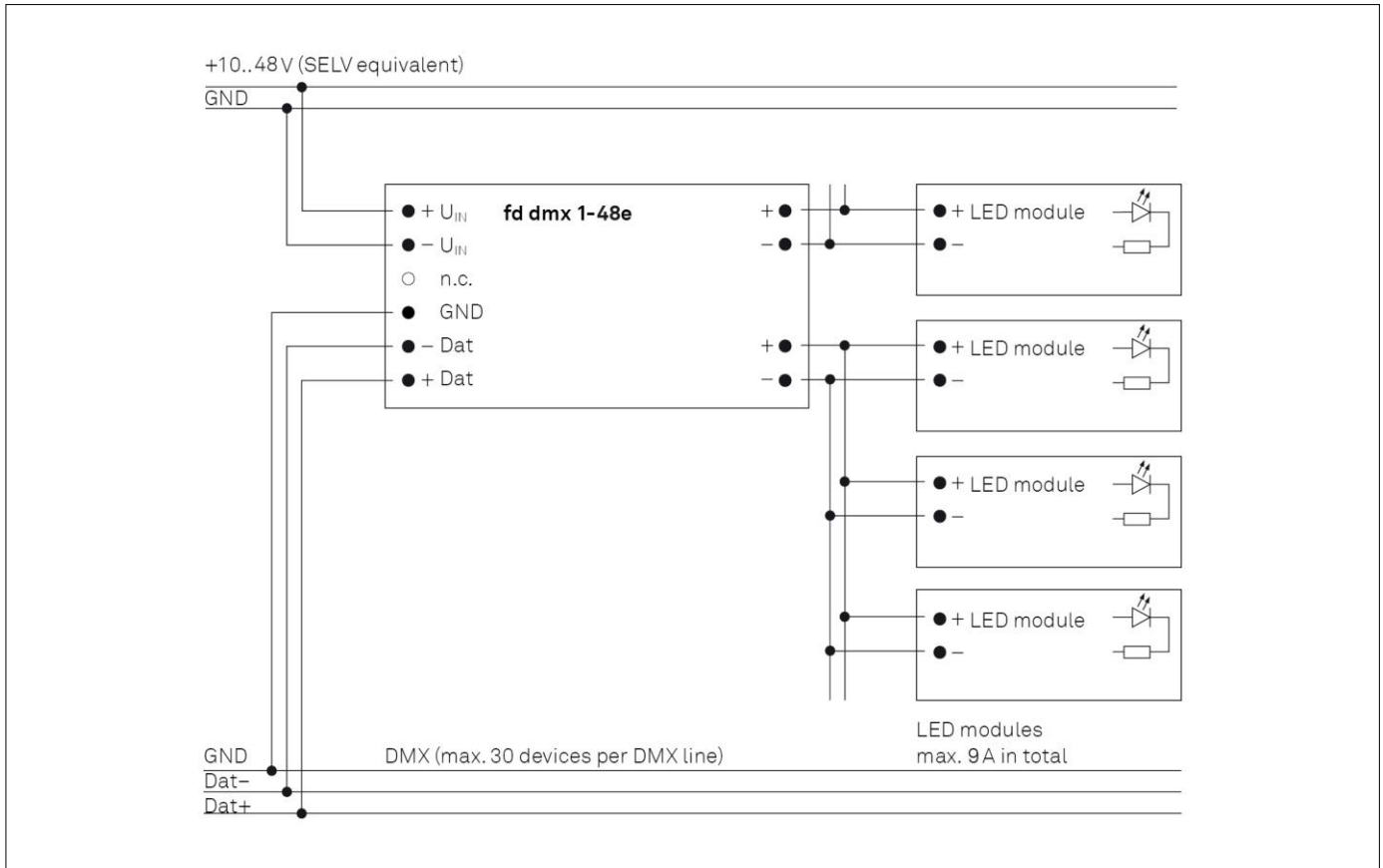

Technical Details

Supply voltage	10..48 V DC (SELV)
Power consumption	9,2 A max.
Control inputs	1
Control signal	DMX
Operating mode	Constant voltage
Outputs	1
Dimming frequency / internal	240 Hz/16 Bit
Output voltage	10..48 V DC
Output load	1 x 9 A
Outputs short circuit proof	yes
Ambient temperature	-20..45 °C
Dimensions (L/W/H)	167 x 42 x 31 mm
Weight	90 g

Standards

EN 61347-1
 EN 61347-2-11
 EN 61347-2-13
 EN 55015
 EN 61547
 EN 61000-3-2
 EN 61000-3-3